



Easy Score Soccer Set

620812

Ages: 2+ years
Please save sales receipt for proof of purchase.

ADULT ASSEMBLY REQUIRED

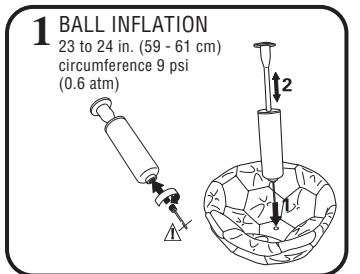
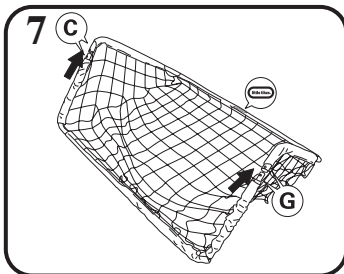
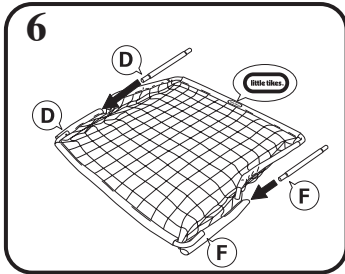
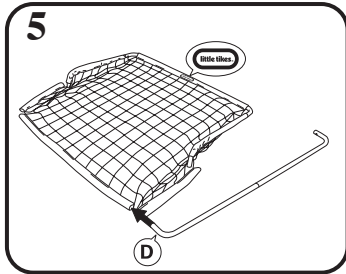
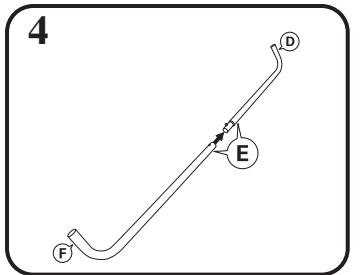
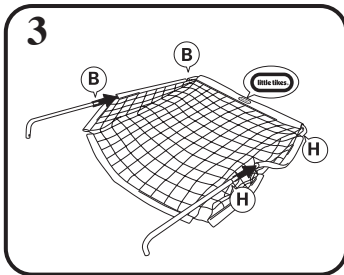
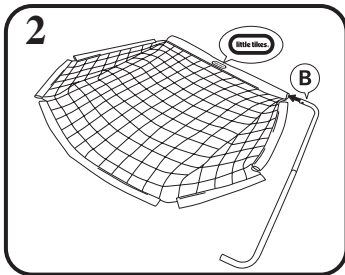
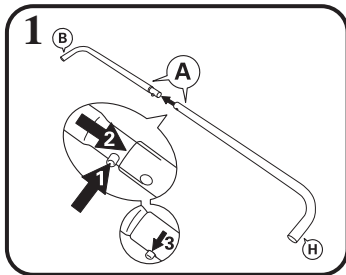
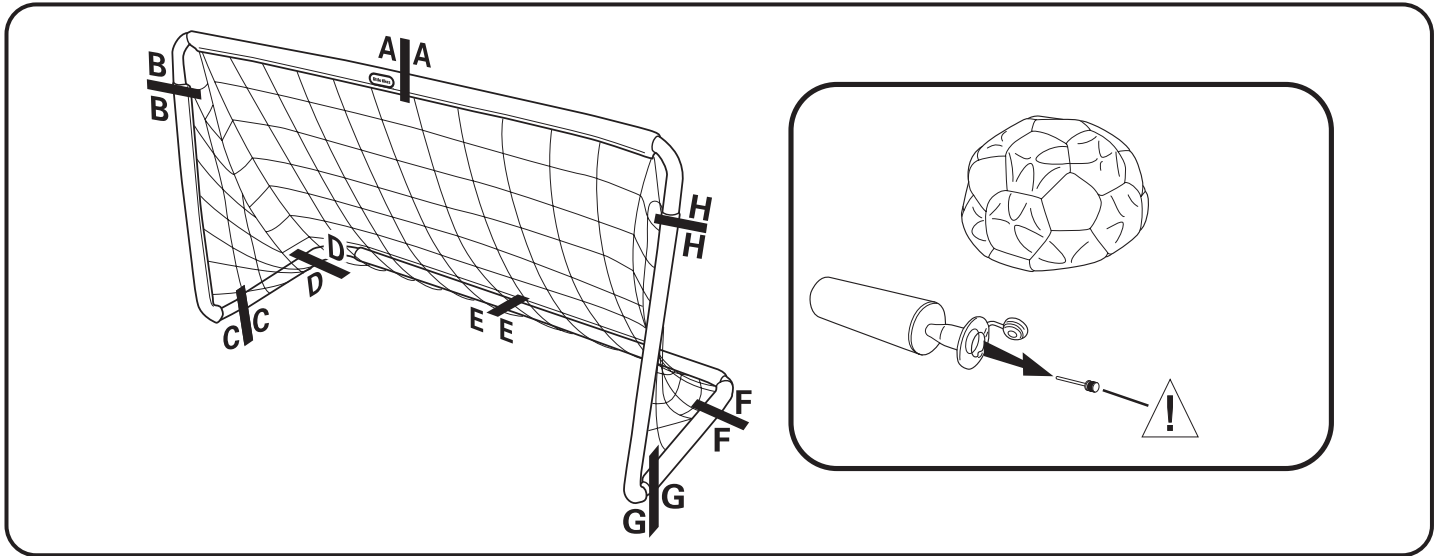

⚠ WARNINGS:

- Place this product on level ground.
- Package contains ball inflation needle. Keep out of reach of children.

TO INFLATE SOCCER BALL:

1. Use only air pump and needle provided.
2. Moisten needle to insert into plug.
3. Inflate ball to approximately 23-24 inch (59-61 cm) circumference, 9 psi (0.6 atm). Do not overinflate.

LIMITED WARRANTY

The Little Tikes Company makes fun, high quality toys. We warrant to the original purchaser that this product is free of defects in materials or workmanship for one year * from the date of purchase (dated sales receipt is required for proof of purchase). At the sole election of The Little Tikes Company, the only remedies available under this warranty will be either replacement of the defective part of the product or refund the purchase price of the product. This warranty is valid only if the product has been assembled and maintained per the instructions. This warranty does not cover abuse, accident, cosmetic issues such as fading or scratches from normal wear, or any other cause not arising from defects in material and workmanship. U.S.A and Canada: For warranty service or replacement part information, please visit our website at www.littletikes.com, call 1-800-321-0183 or write to: Little Tikes Consumer Service 16300 Roscoe Blvd, Suite 150 Van Nuys, CA 91406 U.S.A. Some replacement parts may be available for purchase after warranty expires - contact us for details. Outside U.S.A and Canada: Contact place of purchase for warranty service. This warranty gives you specific legal rights, and you may also have other rights, which vary from country/state to country/state. Some countries/states do not allow the exclusion or limitation of incidental or consequential damages, so the above limitation or exclusion may not apply to you. *The warranty period is three (3) months for daycare or commercial purchasers.

Please keep this manual as it contains important information.



0810-0-E/INT

© The Little Tikes Company, an MGA Entertainment company. LITTLE TIKES® is a trademark of Little Tikes in the U.S. and other countries. All logos, names, characters, likenesses, images, slogans, and packaging appearance are the property of Little Tikes. Little Tikes Consumer Service 2180 Barlow Road Hudson, Ohio 44236 U.S.A. 1-800-321-0183 Printed in China

Little Tikes, MGA Entertainment UK Ltd. 50 Presley Way Crownhill Milton Keynes MK8 0ES UK + 0800 521 558



www.littletikes.com or www.littletikes.co.uk